

# SCREEN-PRINTING SOLUTION

| GL PLUS | P-PRIMO | P-MAXII



---

# SCREEN-PRINTING PORTFOLIO

---



| *GL PLUS SCREEN PRINTER*

Universal  
510 × 510 mm  
Printing accuracy of  
± 25 µm



| *P-PRIMO SCREEN PRINTER*

Mid-Size  
850 × 610 mm  
Printing accuracy of  
± 25 µm



| *P MAXII SCREEN PRINTER*

Large scale  
For PCBs sizes of  
up to  
1220 × 800 mm

# MACHINE DIMENSIONS

## DIMENSIONS GL PLUS

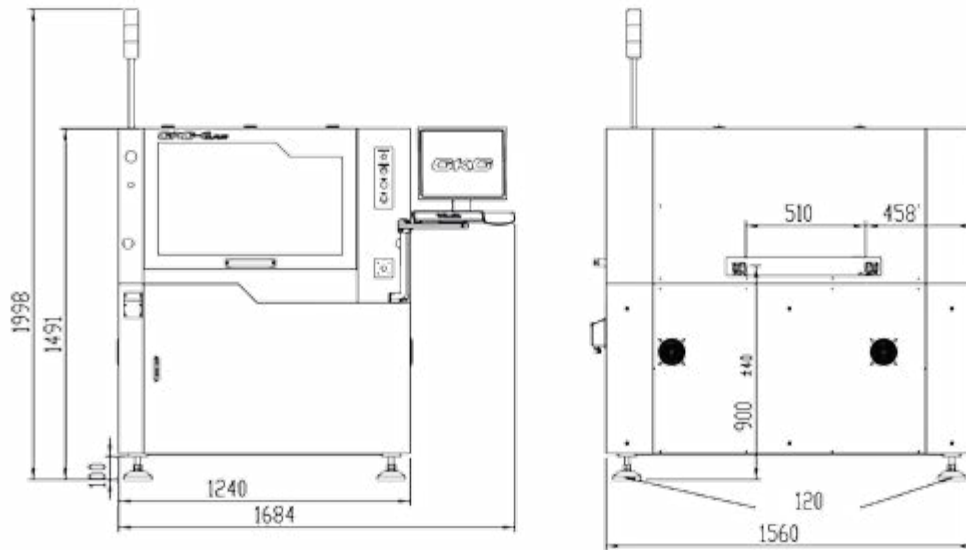

## DIMENSIONS P-PRIMO

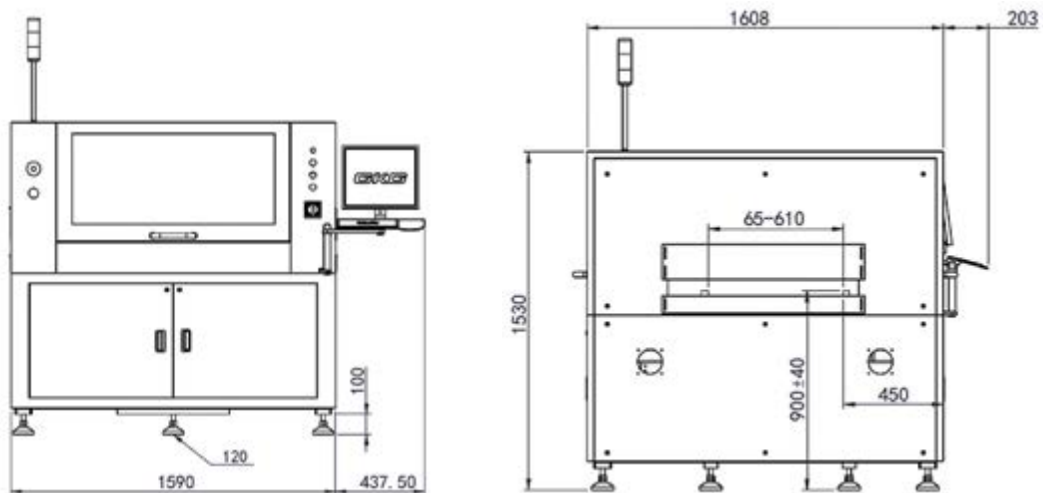

## DIMENSIONS P-MAXII

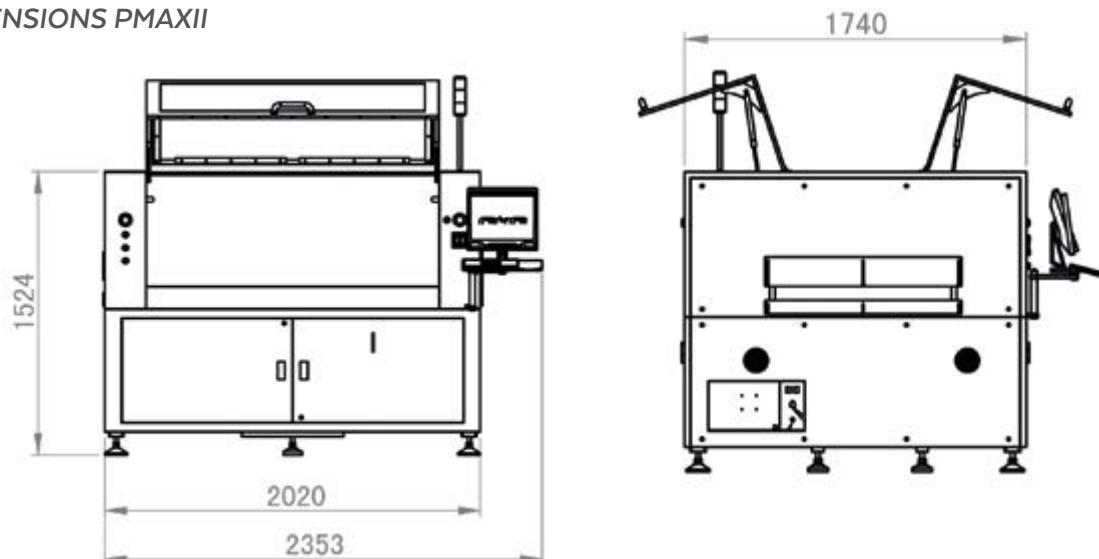

# THREE MACHINES - ONE TECHNICAL CONCEPT

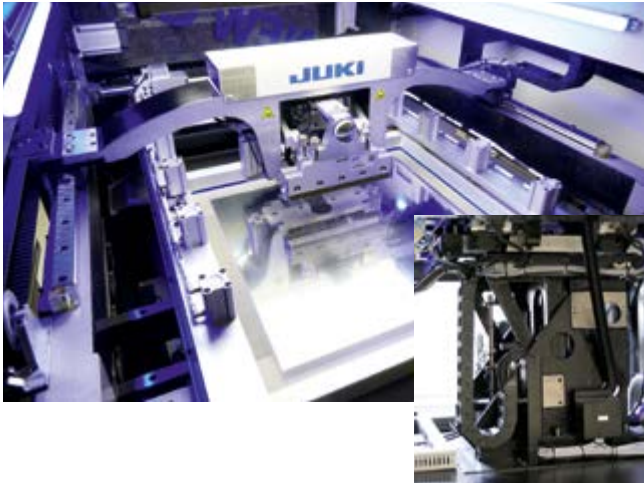

## LONG-LASTING ACCURACY

JUKI's screen printers made by GKG have been designed for three-shift operation and a long service life with low maintenance requirements. They have proven themselves hundreds of times over since they were launched in Europe. In Asia, GKG has already evolved into the leading brand in the area of screen-printing.

The machine table and squeegee carrier are cast, not welded. This guarantees high torsion resistance, while the print accuracy will remain unchanged for years.

JUKI gives a three-year warranty.

## HIGH FLEXIBILITY

Machines from JUKI's Line Solution Portfolio enable needs-based, individual line solutions: from best-price-per-value variants with GL PLUS to high-volume solutions with K3 to LED long board lines with PMAXII.



## OPTIMISED OPERATION AND MAINTENANCE

Straightforward Windows-based operator software enables fast training and programme creation.

A programme change takes about two minutes, while a new creation will be completed within approximately ten minutes.

Large covers and service doors allow for easy access to all assemblies.



# STANDARD EQUIPMENT

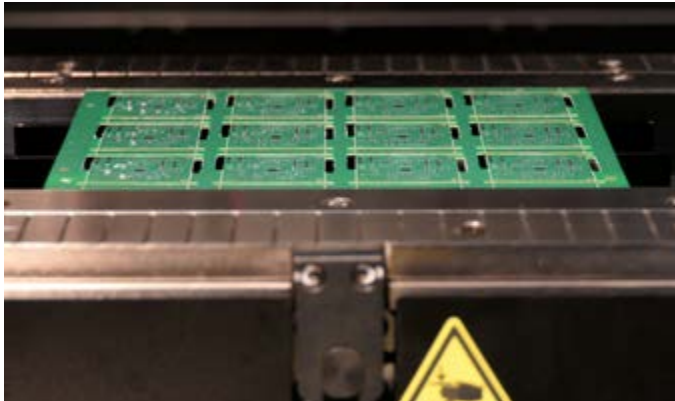

## TOP AND SIDE CLAMP

In order to be able to achieve reproducible printing results, the PCB's secure fixation is of vital importance.

Thanks to the infinitely variable side clamp, sensitive PCBs can be clamped, too.

Very thin or warped PCBs can be securely fixed by means of the retractable top clamp.

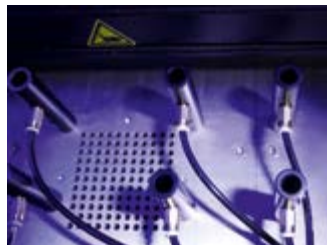

## SUPPORT TOOLS

Every machine is equipped with a set of support tools that perfectly support the PCB during the printing process. All printers are prepared for the use of vacuum supports.



## INTEGRATED 2D PASTE INSPECTION

After each print, the PCB can be checked by means of 2D paste inspection. Print misalignments, lack of paste and solder bridges are detected reliably, well before the PCB leaves the machine. Thus, troubleshooting measures can be taken in good time.



## AUTOMATIC SCREEN UNDERSIDE CLEANING

Thanks to regular screen underside cleaning, it is possible to guarantee consistent print quality. The cleaning cycles can be programmed individually for each product (dry/wet/with vacuum).

# AVAILABLE OPTIONS



## SETUP CONTROL AND TRACEABILITY\*

Accurate machine setups (using the matching solder paste, stencil, squeegee etc.) and exact process documentations are important these days.

These two objectives can be achieved when connecting the machines to Cogiscan Track Trace Control software.

Production does not start until all setup prerequisites are met. During the process, all process-relevant parameters are recorded separately for each PCB.

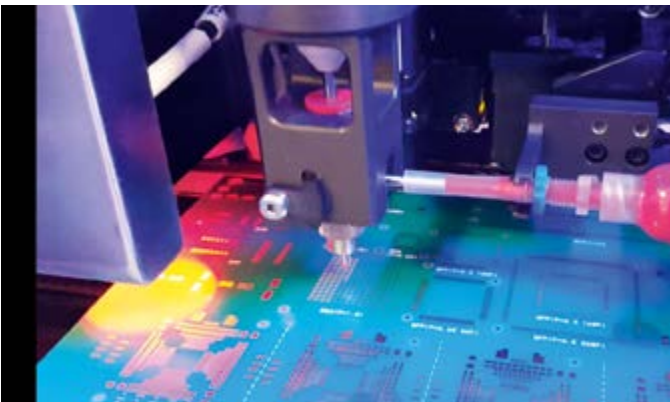

## ADHESIVE DISPENSER\*

Using the dispenser, it is possible to apply additional adhesive points or lines for components. The partial application of additional solder paste is, of course, also possible.



## STENCIL INSPECTION\*

Prior to each print process, the stencil can be checked for soiling at any intervals. If individual apertures are clogged with solder paste, the cleaning process will be activated automatically. Thus, print errors can be avoided early on.

\* Not available with all machine variants.

# AVAILABLE OPTIONS

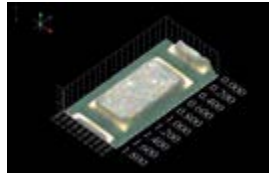

## CLOSED LOOP SPI\*

Print misalignments can be compensated automatically during the process due to the connection to different SPI systems (e.g. made by JUKI). If there are any errors beyond a defined threshold value, the print of any further PCBs will be stopped immediately.

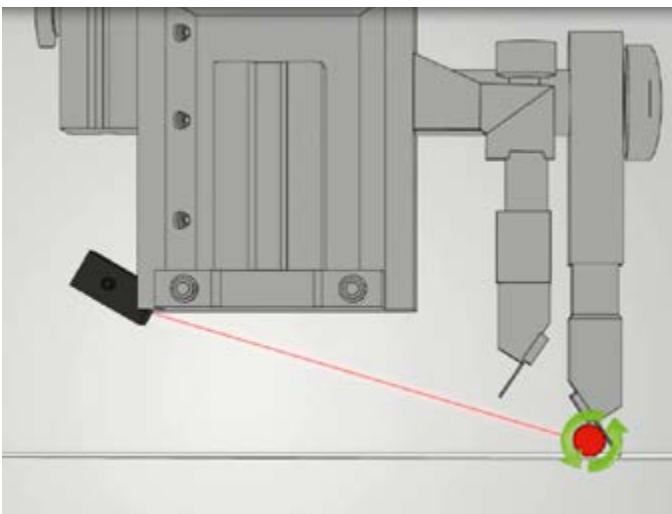

## CONTROL OF THE SOLDER BEAD THICKNESS\*

A laser beam scans the solder bead diameter. If a certain minimum diameter is not achieved, an alarm message will be displayed to the operator. When combined with the paste dispenser option, the missing quantity can be added automatically. Thus, there will always be enough solder paste available during the running process.



## PASTE DISPENSER\*

A defined paste quantity can be applied to the stencil. The intervals can be set as desired. Thus, the paste bead keeps a constant diameter. The paste can be added in cartridges or tins.

\* Not available with all machine variants.

## SPECIFICATIONS

	GL PLUS	P-PRIMO	PMAXII
<b>PCB</b>			
Min. / max. size (L x W in mm)	50 x 50/ 510 x 510	100 x 65/ 850 x 610	100 x 65/ 1220 x 800
Min. / max. thickness (in mm)	0,4/6	0,4/8	0,4/10
PCB margin in mm	3	3,5	5
Max. PCB weight in kg	5	5	10
<b>Stencil</b>			
Min. / max. frame size (L x D in mm)	480 x 500/ 737 x 737	737 x 737/ 1100 x 850	737 x 737/ 1500 x 1250
Min. / max. frame thickness in mm	12/43	12/43	12/43
Fixed and interchangeable frame possible	✓	✓	✓
<b>PCB handling and transport</b>			
Side clamp	✓	✓	✓
Retractable top clamp (for thin/warped PCB)	✓	(Mechanically adjustable)	✓
Adjustable clamping pressure	✓	✓	✓
PCB feed height in mm	950 +/- 20		
Feed/removal direction	left/right, right/left, left/left, right/right		
PCB width/thickness adjustment	automatic		
<b>Print</b>			
Number of squeegee heads	2, contact pressure separately adjustable		
Included squeegee lengths	210, 350, 520 mm x 60° metal	280, 410, 620 mm x 60° metal	850, 1250 mm x 60° metal
Squeegee contact pressure in kg	0-10	0-10	0-30
Print speed in mm/s	10-200	10-200	5-150
Special squeegee available	✓	✓	✓
Other squeegee lengths available	✓	✓	✓
<b>Machine properties and dimensions</b>			
Print accuracy	+/- 25 µm		
Cycle time in s (without printing and cleaning)	< 8,5	< 9,5	< 25
Dimensions (L x W x H in mm)	1240 x 1560 x 1491	1340 x 1697 x 1477	2020 x 1740 x 1528
Weight in kg	1200	1200	1800
<b>PC and Software</b>			
Operating system	Windows 7		
Interfaces	Ethernet, USB, SMEMA, Cogiscan IFSNx/TTC		
<b>Operating requirements</b>			
Power supply	220 V +/- 10 %, 50/60 Hz AC		
Compressed air	6 bar		
Ambient conditions	5-40° C, 20-65 % RH		
<b>Standards (selection)</b>			
	2D SPI, automatic stencil cleaning, PCB vacuum fixation, set of PCB support tools, 3 years of JUKI warranty		
<b>Available options and accessories (selection)</b>			
	Screen inspection, paste dispenser, paste bead thickness control, grid tools for supporting the PCB, closed-loop SPI, air conditioning in process area		

10/2017\_Rev02

Specifications and design subject to change without notice.